



# Tango 98

## 电脑灯控制台 *Scanner Controller*

中/英文使用说明书  
Manual in Chinese/English

顾德电子有限公司  
CODE ELECTRONIC CO., LTD.



CODE Tango 98 电脑灯控制台采用国际通用的 DMX512 数码格式，能控制 12 支 8 通道的电脑灯及其它设备，可同时运行走灯程序和电脑灯手动操作。功能简洁，操作灵活方便，特别容易使用。适用于各种歌舞厅、酒吧和小型文艺演出的场合。

## 技术参数

输出信号	DMX512
DMX 控制通道	1-96
控制电脑灯数量	12
每台电脑灯最大控制通道数	8
电脑灯程序	12
每程序最大步数	50
程序步总数	600
走灯速度调节范围	0.25-60 秒/步
程序步间的渐变调节范围	0-100%
显示方式	带背光的 LCD 液晶显示屏，LED 指示灯
DMX 输出接口	XLR-D3F
其它功能	关机、掉电数据保持，各程序速度、渐变值自动记忆
电源	AC 90-240V, 50-60Hz, 4W
体积	482mm x 178mm x 55mm
重量	3Kg

## 安全使用注意事项

- Tango 98 电脑灯控制台必须连接保护地线，确保使用者的安全。
- 当 Tango 98 电脑灯控制台、电脑灯正在运行工作时，切勿带电插拔 DMX512 数据电缆，避免烧毁控制台内的接口电子器件。
- 切勿将任何液体洒在电脑灯控制台上，以免造成电脑灯控制台内部元器件损坏、功能失灵。
- 电脑灯控制台是精密电子设备，请注意防潮、防尘保护，并请定期清洁控制面板。

## 控制台安装

Tango 98 电脑灯控制台包装箱内包括以下项目：

- Tango 98 电脑灯控制台 1 台；
- 电源连接电缆 1 条；
- 产品合格证 1 份；
- 产品使用说明书 1 份。

Tango 98 电脑灯控制台采用国际标准的 19" 4U 安装结构，可采用嵌入操作台面的安装方式，也可以直接安装在 19" 机架上或机柜上。

本机电源具有宽电压范围的稳压特性，适应全世界各国的供电规格。本机连接电源时，请首先检查供电电压是否在本机的适用范围内，以保证设备的安全使用。

如需更换电源保险丝，请参见机后的标志注明的电流容量规格。

## 与电脑灯的连接

根据 DMX512 标准规定，必须采用特性阻抗为  $120\Omega$  的屏蔽式双绞电缆作为各台设备的数据传输电缆。在实际工程应用时，如传输电缆总长度较短，也可以采用音频系统使用的高质量的双芯屏蔽话筒电缆代替。

电缆的两端需自行焊接 XLR 插头，屏蔽网接 XLR 插头的 1 脚，双绞芯线（由不同颜色区分）则分别连接 XLR 插头的 2、3 脚，其中，3 脚为信号正端，2 脚为信号负端，切勿反接。

DMX 信号传输需要在最后一台设备上安装终端  $120\Omega$  匹配电阻，吸收电缆终端的信号反射，确保信号正确传输。具体做法：在 XLR 插头的 2、3 脚焊接 1 个  $120\Omega$  电阻，把此插头插入最后 1 台电脑灯（或其他设备）的联机插座上。

## DMX512 地址分配

Tango 98 电脑灯控制台使用 DMX512 的 1-96 通道向各台电脑灯输送数码控制信号。每台电脑灯固定分配 8 个控制通道。

电脑灯编号	电脑灯 DMX 起始地址	
	十进制	电脑灯地址开关位 123456789
1	1	10000000
2	9	10010000
3	17	10001000
4	25	10011000
5	33	10000100
6	41	10010100
7	49	10001100
8	57	10011100
9	65	10000010
10	73	10010010
11	81	10001010
12	89	10000110

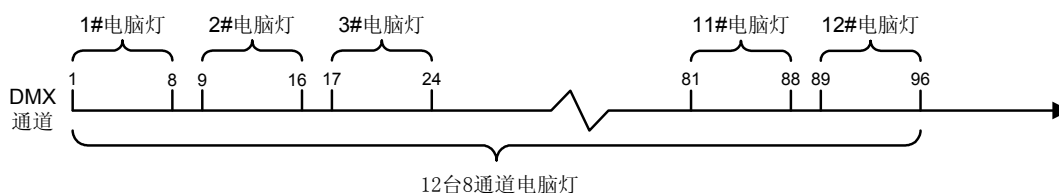

### 系统连接示意图

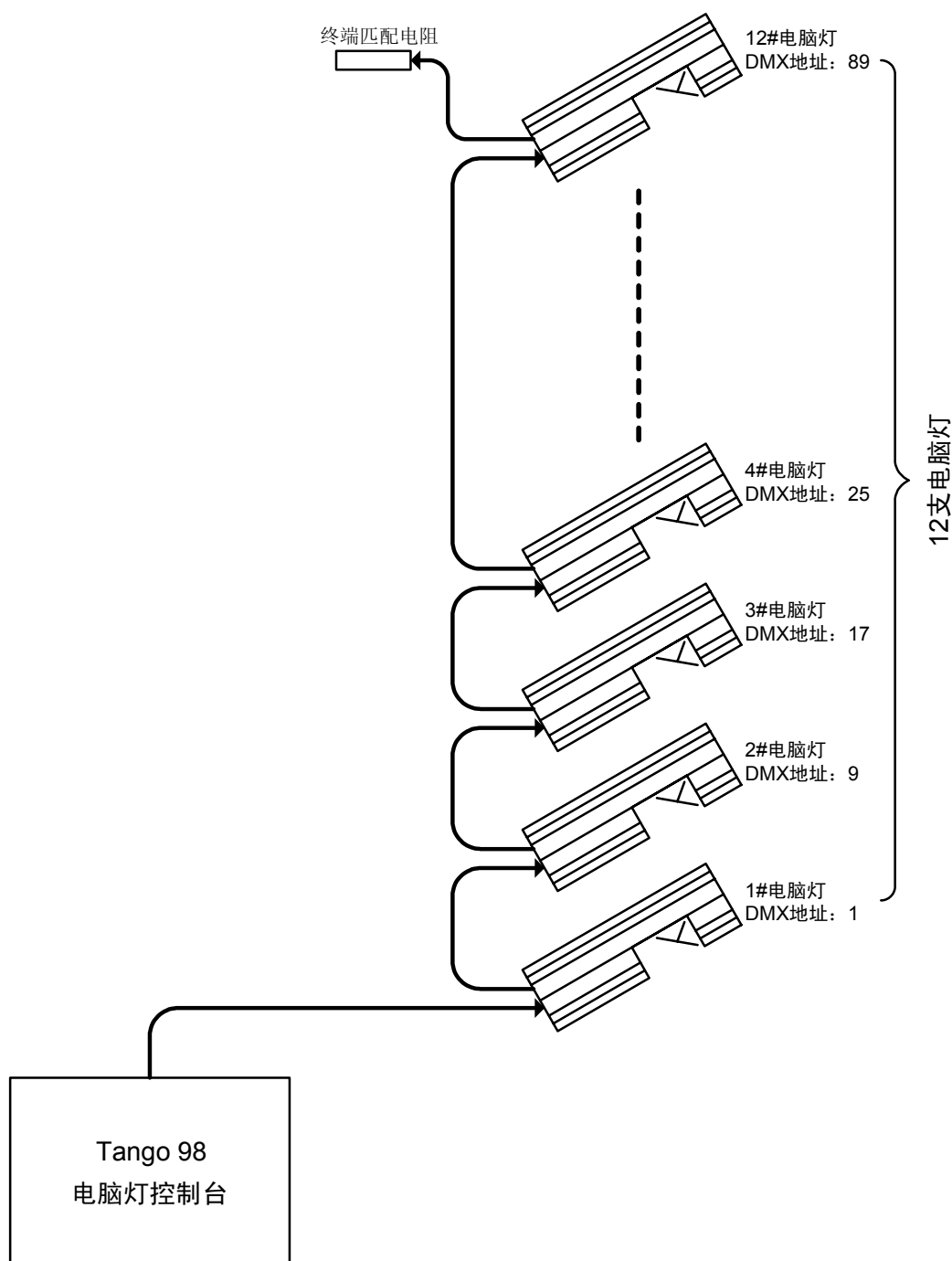

## 面板装置

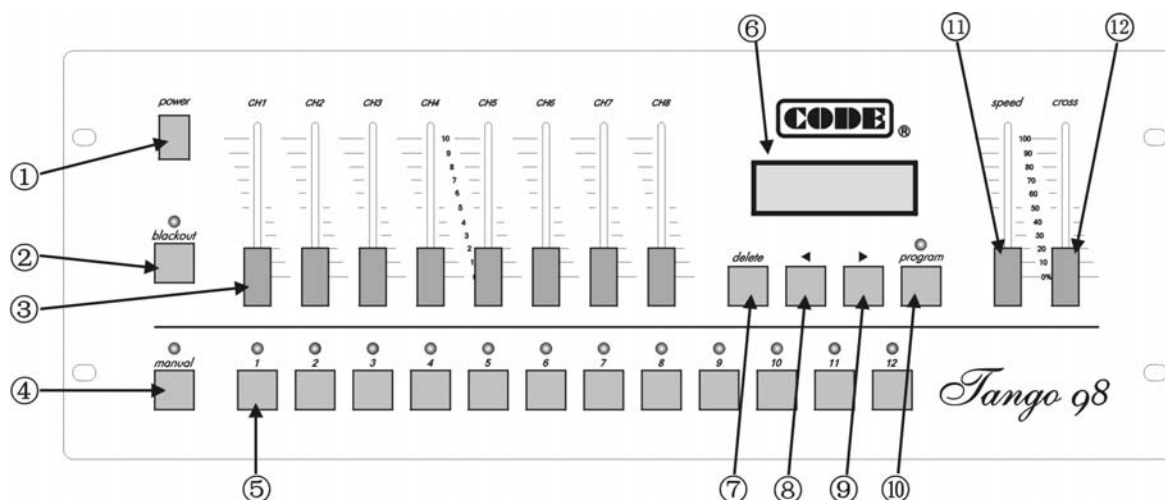

图中编号	名称	功能与用途
1	<b>power</b> 电源开关	控制台的 AC 电源开关。
2	<b>blackout</b> 黑场键	此键的状态由指示灯表示： ◆ 灯亮，控制台处于黑场状态； ◆ 灯熄，控制台处于运行状态。
3	<b>CH1~CH8</b> 通道推杆组	在编程状态下，调整通道推杆可改变指定电脑灯对应通道的控制值。
4	<b>manual</b> 手动操作键	指示灯亮时处于手动操作模式。
5	<b>1~12</b> 数字键	这些数字键用于选择走灯程序、选择电脑灯。
6	<b>LCD</b> 液晶显示屏	显示控制台当前的运行状态和各种设置值。
7	<b>delete</b> 删除键	在编程状态下使用： ◆ 短按则删除当前程序步； ◆ 按住超过 2 秒则快速删除当前程序步，直至把当前走灯程序清空。
8	◀ 方向键	编程时，向后查看各个程序步。
9	▶ 方向键	编程时，可向前查看各个程序步。 如当前步为最后（带*号），按此键自动插入 1 步，并将当前程序步的内容复制到新插入的程序步。
10	<b>program</b> 走灯编程键	◆ 按住此键超过 1 秒，其上方的红灯闪亮，进入编程状态； ◆ 再次按住此键超过 1 秒，红灯熄灭，控制台处于运行状态。
11	<b>speed</b> 走灯速度推杆	调整走灯程序的运行速度，0=最慢，100%=最快。
12	<b>cross</b> 渐变推杆	调整程序步间的渐变过渡时间控制，0=最慢，100%=最快。

## 后板装置

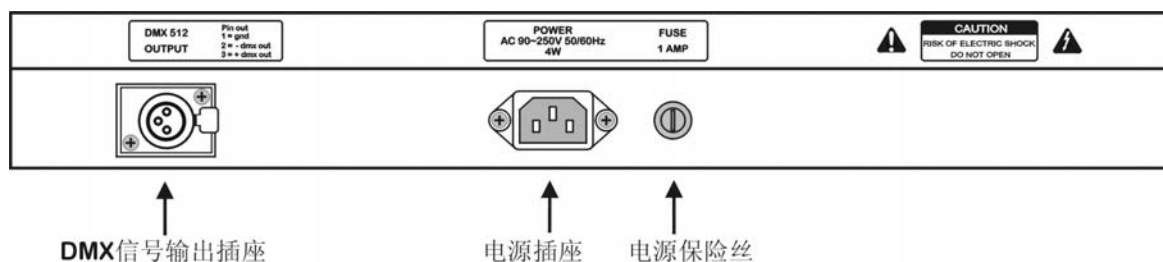

## LCD 屏幕显示信息

显示内容	详细解释
[BLACKOUT]	按 <b>blackout</b> 键，红灯亮，处于黑场状态。
[On line]	按 <b>blackout</b> 键，红灯熄灭，处于运行状态。
Select Chase	请选择需要运行的电脑灯走灯程序。
Chase: xxx	xxx 当前走灯程序的号码。
Step: [xx]	xx 当前程序步的号码。
Speed [xxx%]	调节 <b>speed</b> 控制推杆时显示，xxx 范围：000%-100%，000%=最慢，100%=最快。
Cross [xxx%]	调节 <b>cross</b> 渐变控制推杆时显示，xxx 范围：000%-100%，000%=最慢，100%=最快。
Step is empty!	当前走灯程序没有内容，全空白。
==PROGRAM== Select chase:	当按下 <b>program</b> 键超过 1 秒进入编程状态后，提示请选择 1 个走灯程序号。
PROG CHASE: XXX	xxx 当前正在编辑的电脑灯程序号
Step: [xxx]*	用 * 号表示此程序步是最后一步。

注：以 x 代表数字

## 电脑灯走灯程序的运行

1. 按 **1~12** 数字键，运行对应编号的电脑灯走灯程序。
2. 如果数字键对应的程序尚未编辑，按此数字键绿灯不亮，显示屏同时显示此程序为空。
3. 用 **speed** 速度推杆改变当前程序的运行速度，控制台会自动记忆每个程序的运行速度值。0%=最慢，100%=最快。
4. 用 **cross** 渐变推杆改变当前程序的步间渐变过渡，控制台会自动记忆每个程序的运行速度值。0%=最慢，100%=最快。
5. **blackout** 键有两种状态：
  - ◆ 红灯亮，控制台处于黑场状态；
  - ◆ 红灯熄灭，控制台处于运行状态。

Tango 98 电脑灯控制台具有断电后资料储存保护功能，运行时断电或关机，控制台自动记忆最后的运行状态，重新开机或来电后，自动接续运行。

## 电脑灯走灯程序的编辑

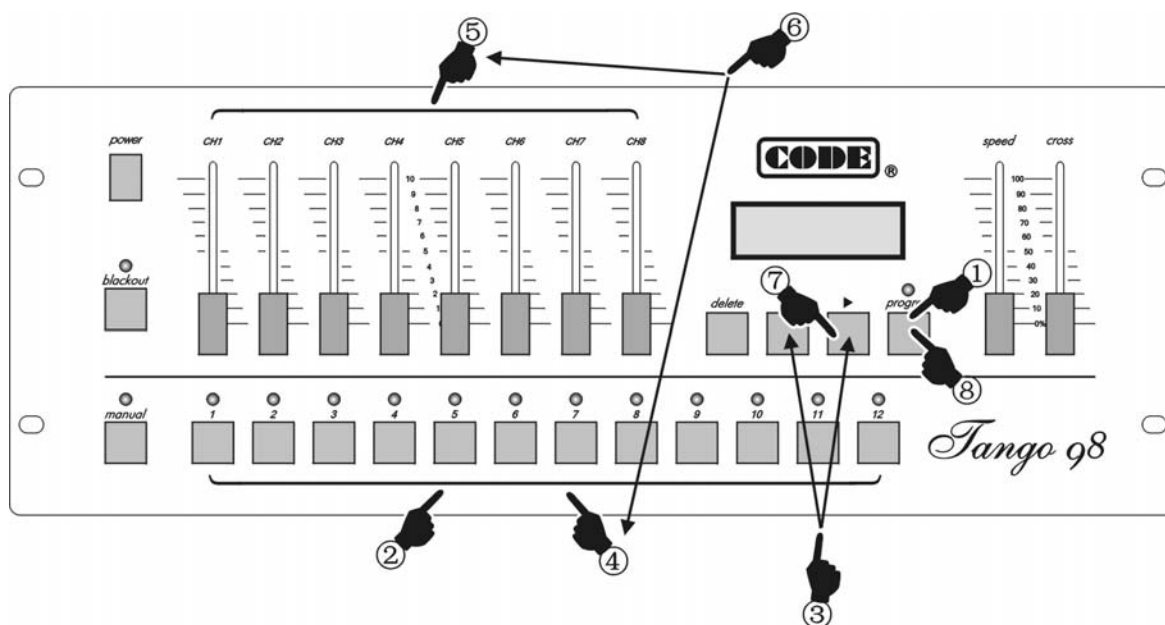

1. 按住 **program** 键超过 1 秒，进入编程状态；
2. 用数字键选择要编辑的程序号码；
3. 用 ▶、◀ 键改变当前编辑的程序步，如当前为最后程序步则屏幕上有\*号；
4. 按数字键选择当前步要编辑的电脑灯号；
5. 调整 **CH1-CH8** 推杆，设置电脑灯各通道值；
6. 重复 4~5 步，设置其他电脑灯通道值；
7. 按 ▶ 键，编辑下一个程序步。如当前程序步为最后步（带\*号），则自动把当前程序步的内容复制到下一个程序步中。重复 4~6 步，编辑其他程序步；
8. 按住 **program** 键超过 1 秒，推出编程状态。重复 1~8 步，编辑其他程序。

### ▶、◀ 键的使用功能

这两个键仅在编程状态下使用：

1. ▶、◀ 键都可以翻查已编辑程序步的灯光效果；
2. ▶ 键的插入、复制功能（举例说明）：
  - ◆ 如当前程序内容为空，进入编程后 LCD 屏幕将显示 “Step [001] \*”，表示当前步号码=001，并且是最后一步（\*号代表最后的程序步）。
  - ◆ 设置好 “Step [001]” 步的各台电脑灯的各个通道参数后，按 ▶ 键，插入一个新的程序步 002，显示 “Step [002] \*”，表示当前的 002 程序步是最后一步，并且自动将 001 程序步的全部内容复制到 002 程序步。



## delete 删除键的使用

- ◆ 编程状态下，短暂按此键，删除当前编辑的程序步；
- ◆ 编程状态下，按住此键超过 1 秒，快速删除程序步。当全部的程序步都被删除后，当前程序就是空程序。
- ◆ 电脑灯手动操作状态下，按此键可清除手动操作的记忆。

## 编程提示

- ◆ 编好当前程序后，要先退出编程状态，然后再进入编程状态，编辑另一个程序。
- ◆ 注意▶键的使用，要充分理解使用方法，否则容易插入不必要的无用的或全黑程序步。
- ◆ 可编辑只含 1 步的电脑灯程序，作为电脑灯固定场景使用。
- ◆ 在编程时不涉及 **speed** 和 **cross** 的设定，在各程序运行状态下直接设置并自动记忆。

## 编程操作示意图

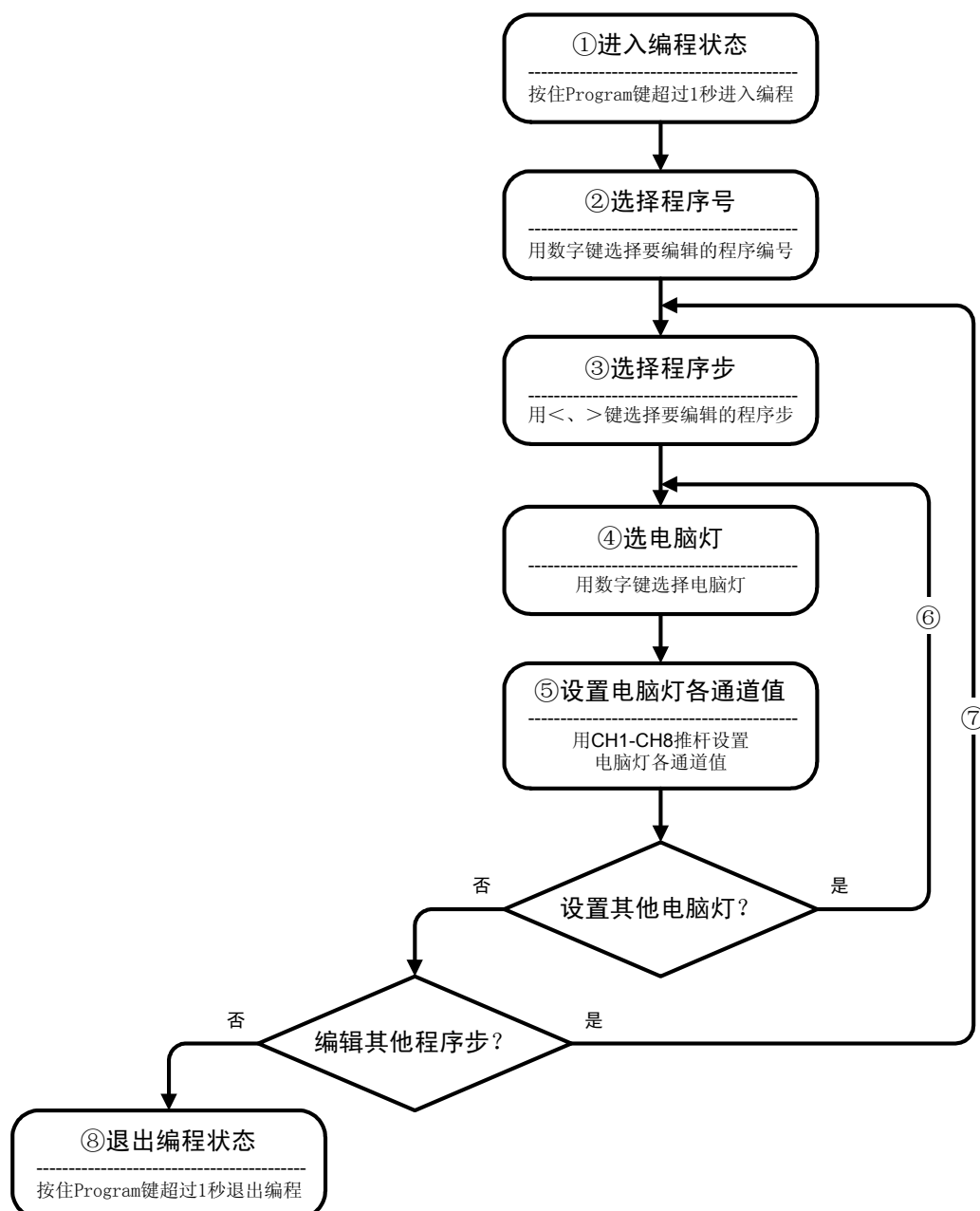

## 电脑灯手动操作

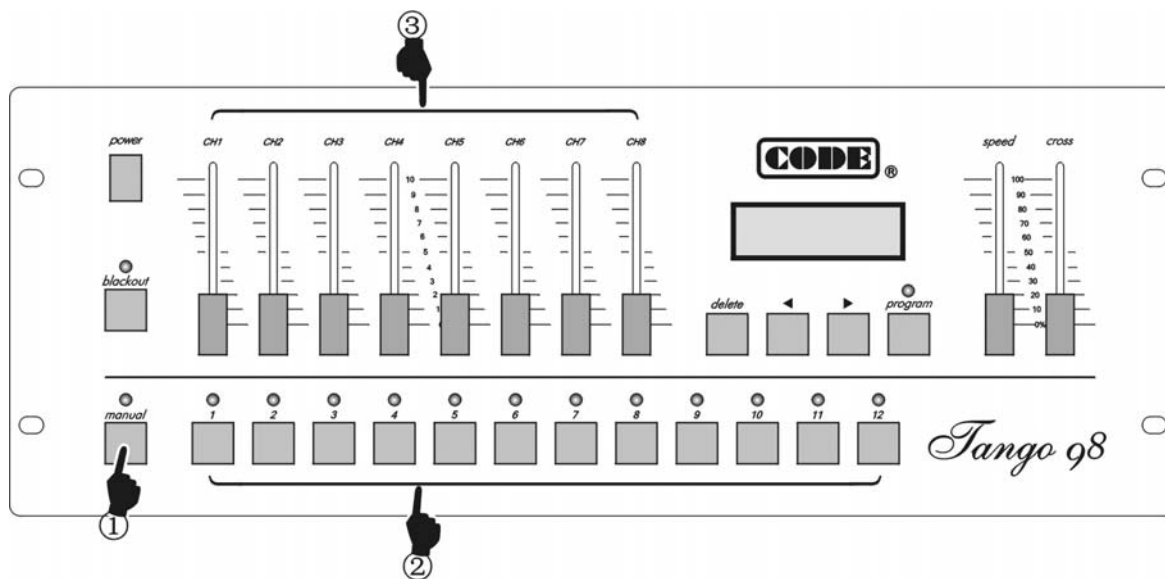

1. 按 **manual** 键；
2. 用数字键选择手动操作的电脑灯，可多选；
3. 用调整 **CH1~CH8** 推杆，设置电脑灯的各参数，显示屏显示最后设置的通道值。推动推杆，令推杆值越过电脑灯当前的控制值之后，电脑灯才接受推杆控制。
4. 再次按 **manual** 键，取消电脑灯手动操作。控制台会记住最后的手动操作各参数，再次进入手动操作时恢复到此状态。
5. 在手动操作状态下，若按 **delete** 键，清除手动操作参数的记忆。

### 提示：

- ◆ 如果同时选择多台电脑灯，调整推杆时，同时作用于被选的电脑灯。
- ◆ 在走灯程序运行时，可执行手动操作。

According to the universal DMX512 protocol, CODE Tango 98 scanner controller can control twelve 8-channel scanners or other equipment. Chase program and manual control of scanners can be performed at the same time. Its functions are compact. Its convenient and flexible operation made it be handled very easily. Tango 98 is suitable for different ballroom, taproom and small show.

## Technical specifications

Output signal	DMX512
DMX channels	1-96
Control amount of scanners	12
Maximum control channel amount of a scanner	8
Manual operation of scanner	✓
Amount of chase programs	12
Maximum chase steps in a chase	50
Total chase steps	600
Range of chase speed	0.25-60s/step
Ratio range of cross between steps	0-100%
Display mode	LCD display and LED indicator
Port of DMX output	XLR-D3F
Other functions	Auto save for every data when power off and auto save for chase speed and cross ratio.
Power supply	AC 90-240V, 50-60Hz, 4W
Size	482mm x 178mm x 55mm
Weight	3Kg

## Cautions for safety

- Tango 98 scanner controller must be connected to earth ground to ensure the safety of user.
- When Tango 98 and scanners are working, don't plug in or pull out DMX512 data cable to avoid destroying the electric components of the port in the controller.
- Don't splash any liquid to the controller to avoid destroying the electric components and the functions of the controller.
- The scanner controller is precision electric equipment. Please pay attention to moistureproof protection and dustproof protection. And please clean the controller panel termly.

## Installation of controller

Contents in the package of Tango 98 scanner controller:

- Tango 98 scanner controller 1;
- Power supply line 1;
- Certification of QC 1;
- User's Manual 1.

Installing structure of Tango 98 scanner controller follows international standard 19" 4U. It can be embedded in operation board or directly installed in 19" shelf or cabinet.

The power of Tango 98 scanner controller has steady voltage output in so wide range of power supply voltage that it is adapted to the power supply of many countries. Before the power supply is connected, please check whether the voltage is in normal range of Tango 98 to ensure the safety.

When the fuse needs to be replaced, please use the fuse with the current capacity signed on the rear of Tango 98.

## Connecting to scanner

According to DMX512 protocol, DMX signal cable must be screened twist cable with impedance of  $120\Omega$ . In practical engineering installation, if the whole length of the cable is short, the cable may be replaced by high quality screened two-core microphone cable.

User joins each end of the cable to a XLR plug. Foot 1 of the XLR plug is connected to the screen net of the cable. Twist lines (distinguished by different colors) are connected to foot 2 and 3. Foot 3 is signal + and foot 2 is signal -. Foot 2 and foot 3 of the plug cannot be confused.

To ensure correct DMX signal transmission, an  $120\Omega$  terminal matching resistance must be connected to the last equipment to absorb terminal signal reflection. The operation is as following: connect a  $120\Omega$  resistance to foot 2 and foot 3 of a plug then plug it to the output of the last scanner (or other equipment).

## Address distribution of DMX512

Tango 98 scanner controller utilizes channel 1-96 of DMX512 to transmit the control signals to various scanners. Each scanner is fixed with 8 control channels.

Scanner No.	First DMX address of scanner	
	Decimal Code	Switch bit of scanner address 123456789
1	1	100000000
2	9	100100000
3	17	100010000
4	25	100110000
5	37	100001000
6	41	100101000
7	49	100011000
8	57	100111000
9	65	100000100
10	73	100100100
11	81	100010100
12	89	100001100

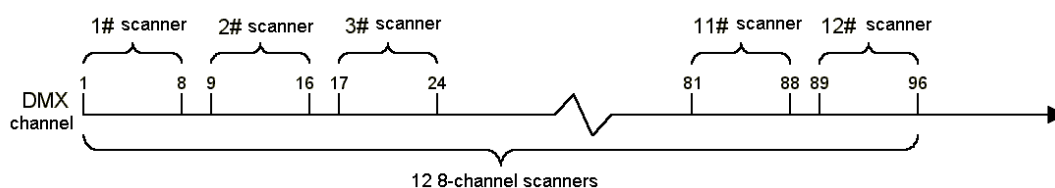

### Schematic of system connection

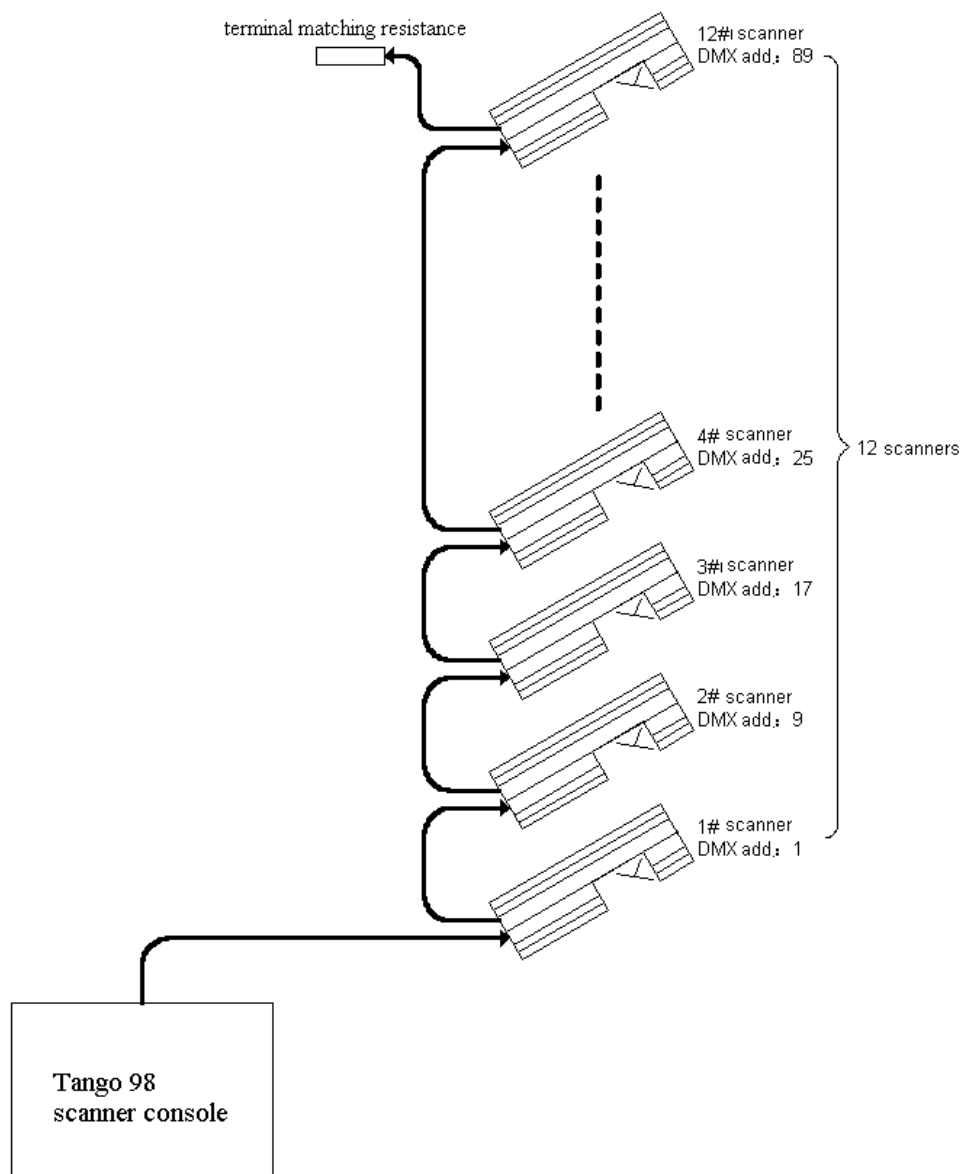

## Panel of Tango 98

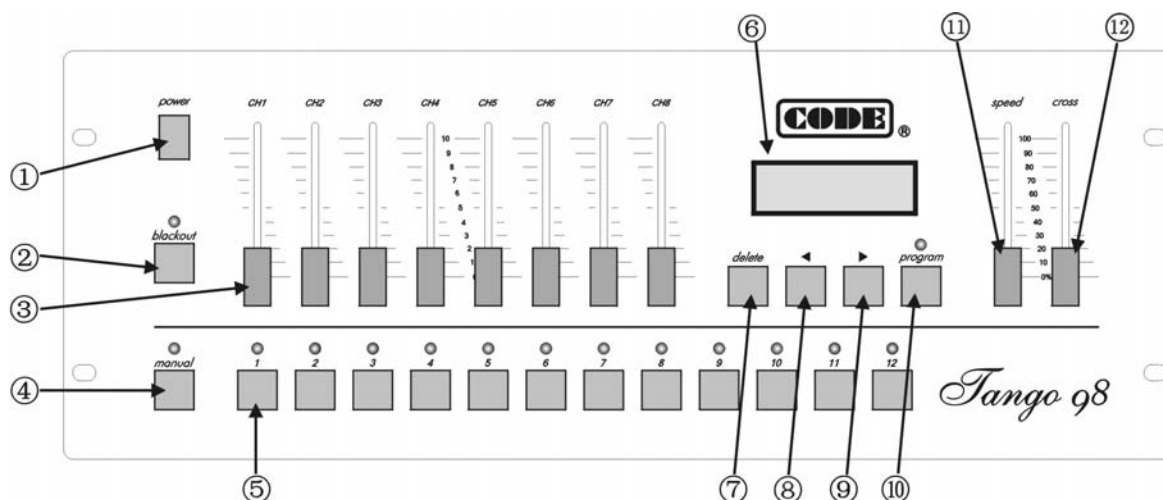

No.	Name	Functions and purposes
1	<b>power</b> switch	Switch of AC power of the controller.
2	<b>blackout</b> key	The key state is indicated by LED as following: <ul style="list-style-type: none"> <li>◆ When its LED is on, the controller is in blackout state;</li> <li>◆ When its LED is off, the controller is in running state;</li> </ul>
3	<b>CH1~CH8</b> channel slider	In program edit, move the slider can change the channel control value of a specified scanner.
4	<b>manual</b> operation key	When its LED is on, the controller is in manual state;
5	Number key <b>1~12</b>	These keys are used to choose chase program and scanner.
6	<b>LCD</b> display	Display the current state of the controller and various setting values.
7	<b>delete</b> key	Be used in program edit state: <ul style="list-style-type: none"> <li>◆ Press the key quickly to delete the current chase step.</li> <li>◆ Press the key for more than 1 second to <u>delete chase steps quickly until the chase program is empty.</u></li> </ul>
8	◀ Direction key	In program edit, use it to check chase steps backwards.
9	▶ Direction key	In program edit, use it to check chase steps forwards. If the current step is the last one (with *), press the key to add a step and copy the contents of the current step to the new one.
10	<b>program</b> key	<ul style="list-style-type: none"> <li>◆ Press the key for more than 1 second, its LED is on and the controller is in chase program edit state;</li> <li>◆ Press the key for more than 1 second again, its LED is off and the controller is in running state;</li> </ul>
11	<b>speed</b> slider	Adjust chase speed, 0=slowest, 100%=fastest.
12	<b>cross</b> slider	Adjust cross time between steps, 0=slowest, 100%=fastest.

## Rear of Tango 98

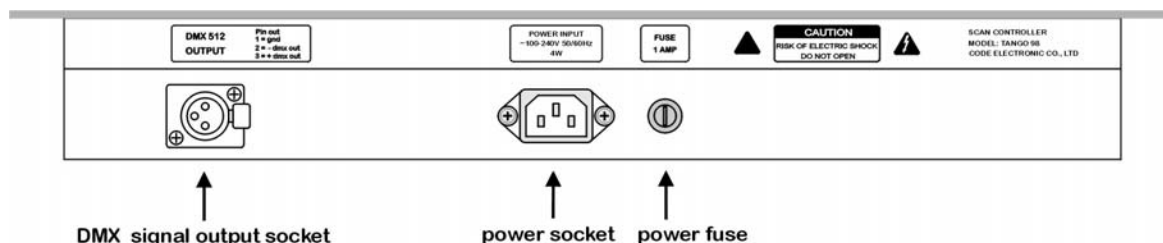

## Information of LCD display

Display contents	illustration
[BLACKOUT]	When <b>blackout</b> key is pressed, its Led is on and the controller is in blackout state.
[On line]	When <b>blackout</b> key is pressed, its Led is off and the controller is in running state.
Select Chase	Please choose chase program wanted to be performed.
Chase: xxx	Number xxx of the current chase program.
Step: [xx]	Number xx of the current chase step.
Speed [xxx%]	Display when <b>speed</b> slider is adjusted. xxx range: 000%-100%, 000%=slowest, 100%=fastest.
Cross [xxx%]	Display when <b>cross</b> slider is adjusted. xxx range: 000%-100%, 000%=slowest, 100%=fastest.
Step is empty!	The current chase program has no content. It is empty.
==PROGRAM==	After pressing <b>program</b> key for more than 1 second, the controller is in program edit state. Please select a chase program number.
Select chase:	
PROG CHASE: XXX	The number xxx of chase program being edited.
Step: [xxx]*	Use * to indicate the chase step is the last one.

Note: x is a number.

## Running of chase program

1. Press number key 1-12 to perform the chase program corresponding to the number.
2. If the chase program corresponding to the number has not been edited, its green light is not on when the number key is pressed. This indicates the chase program is empty.
3. Use **speed** slider to change the running speed of current chase program. The controller will save the speed values of every chase program automatically. 0%=slowest, 100%=fastest.
4. Use **cross** slider to change the cross time between steps of current chase program. The controller will save the cross time values of every chase program automatically. 0%=slowest, 100%=fastest.
5. **blackout** key has two states as following:
  - ◆ When its LED is on, the controller is in blackout state;
  - ◆ When its LED is off, the controller is in running state.

Tango 98 scanner controller has auto save function when power off. When the controller is turned off or the power supply is broken off, it can save the last running state automatically and run from that state continually next time.

## Edit of chase program

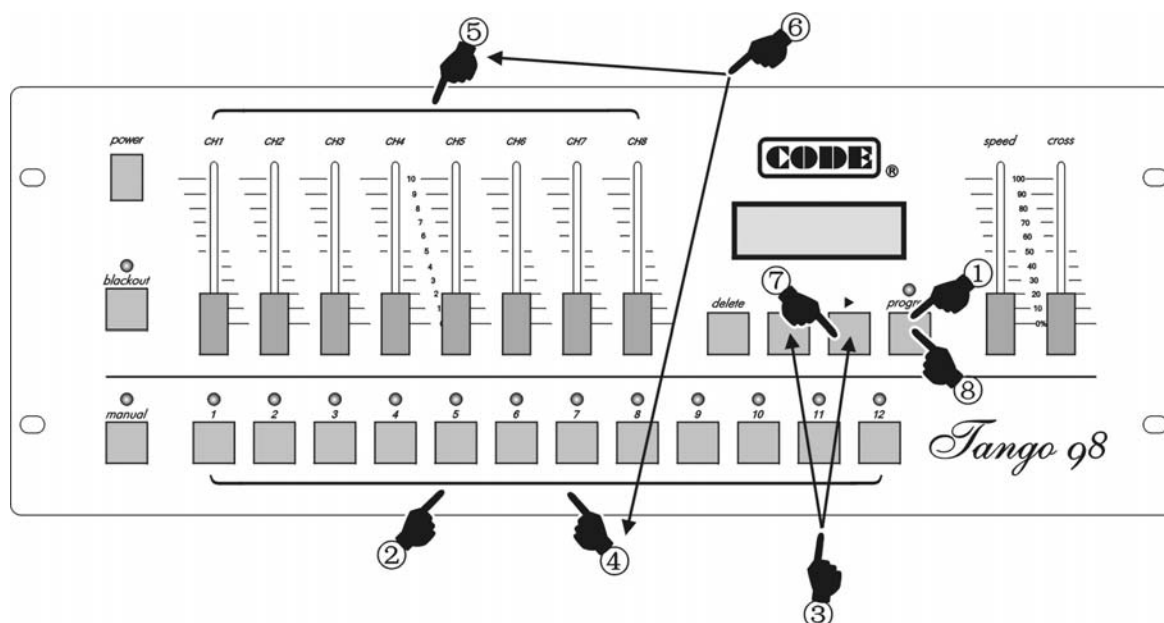

1. Press **program** key for more than 1 second to enter into program edit state.
2. Use number key to choose the number of chase program want to be edited.
3. Use ►, ◀ key to change the current chase step. If the current step is the last one, it has a \* on the screen.
4. Use number key to choose the number of a scanner wanted to be edited.
5. Move **CH1-CH8** slider to set each channel value of the scanner.
6. Repeat steps 4-5 to set channel values of other scanners.
7. Use ► key to next chase step. If the current step is the last one (with \*), it copy the contents of current step to the new one automatically. Repeat steps 4-6 to edit other steps.
8. Press **program** key for more than 1 second to quit from program edit state. Repeat steps 1-8 to edit other chase programs.

## Functions of ►, ◀ keys

They can be used just in program edit state.

1. Use ►, ◀ key to check the lighting effect of edited chase step.
2. Insert and copy functions of ► key (with example):
  - ◆ If current chase program is empty, LCD display will display “Step [001] \*” when the controller goes into program edit state. This indicates that the number of the current chase step is 001 and it is the last one.
  - ◆ After every channel value of every scanner in “Step [001]” are set, press ► key to insert a new chase step 002. “Step [002] \*” is displayed on LCD display. It indicates that step 002 is the last one and the contents of step 001 have been copied to step 002 automatically.



### Functions of Delete key

- ◆ Press the key quickly to delete the current chase step.
- ◆ Press the key for more than 1 second to delete chase steps quickly until the chase program is empty. When all chase steps are deleted, a chase program is an empty chase program.
- ◆ In manual operation state of a scanner, press the key to clear the record of manual operation.

### Tips of program edit

- ◆ When the edit of current chase program is finished, quit from program edit state first, then enter into this state again to edit another chase program.
- ◆ Pay attention and comprehend sufficiently to the usage of ► key. Otherwise unwanted, useless or blackout chase step is inserted.
- ◆ A chase program just with one step can be edited as a fixed scanner scene.
- ◆ In program edit, **speed** and **cross** are not set. They are set directly in program running state and saved automatically.

## Schematic of program edit

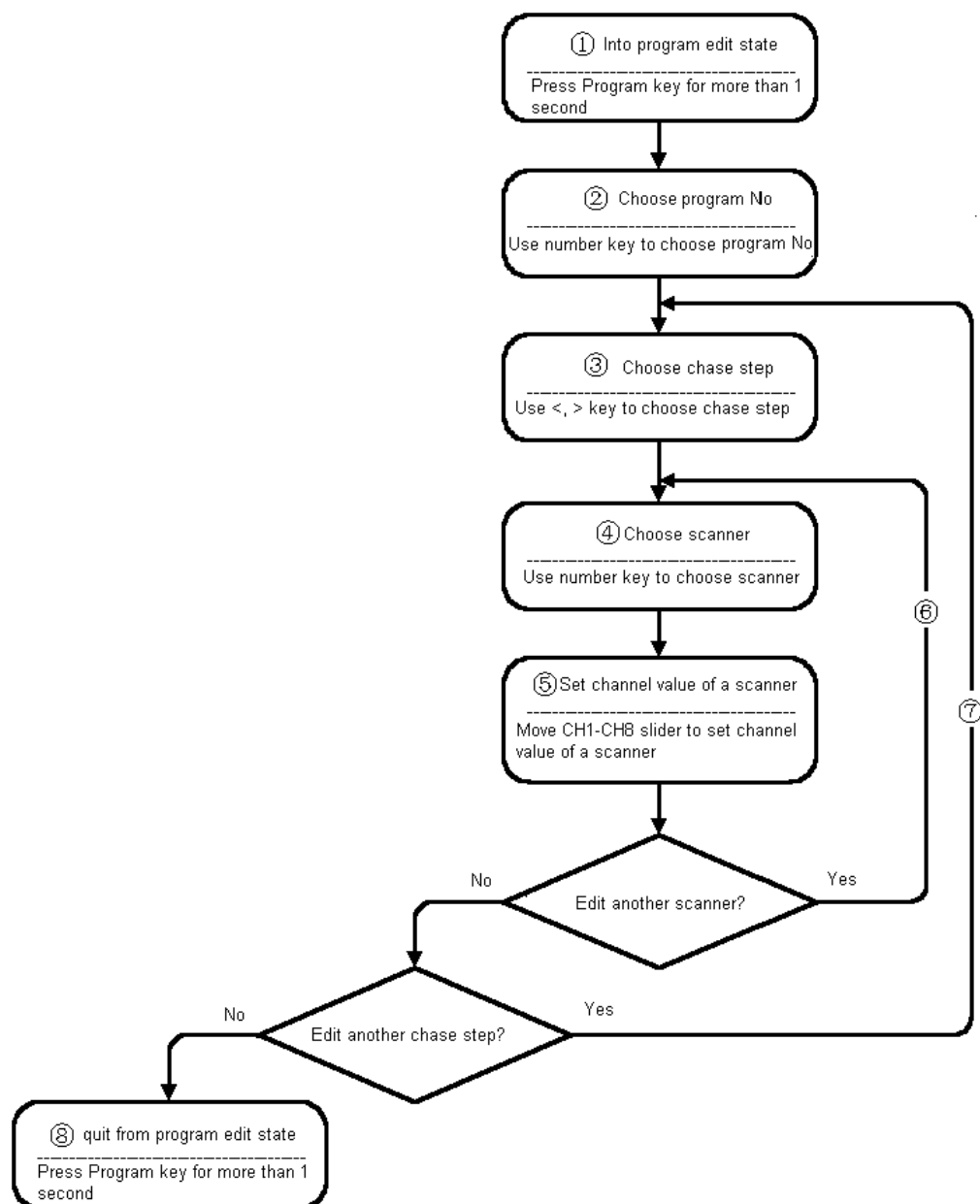

## Manual operation of scanner

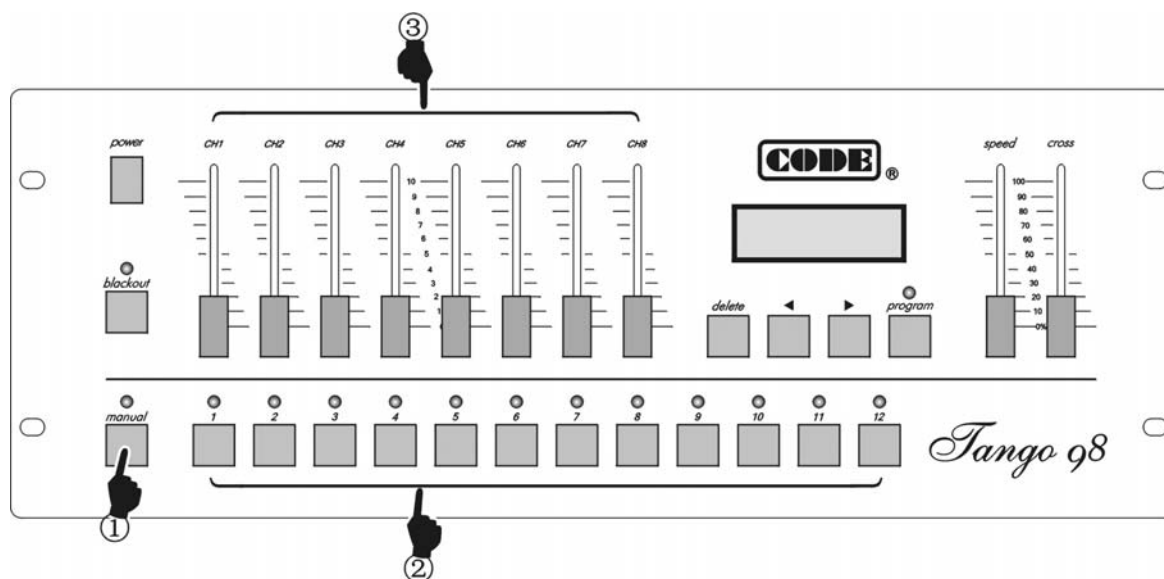

1. Press **manual** key;
2. Use number key to choose scanner wanted to be controlled manually. Multi scanner can be chosen.
3. Move **CH1-CH8** slider to set each channel value of a scanner. Last channel value is displayed on LCD display. After moving slider to make channel value of the scanner larger than the current channel value, the scanner can be controlled by the slider.
4. Press **manual** key again to cancel manual operation of a scanner. The controller can remember the last channel values displayed on LCD display. When the controller enters into manual operation again, the last channel values are resumed.
5. In manual operation state of a scanner, press **delete** key to clear the record of manual operation.

### Tips

- ◆ If multi scanners are chosen, moving channel slider can act on all chosen scanners simultaneously.
- ◆ When a chase program is running, manual operation can be performed.



顾德电子有限公司

CODE ELECTRONIC CO., LTD.

---